

## FELCO 50

Cutter - Hoof clippers

Made in Switzerland by FELCO



220mm/8.7in. 305g/10.8oz.



- **Reliable:** comfortable, light, sturdy handles made of forged aluminium with a lifetime guarantee\* / blade and screw-mounted anvil blade made of high-quality hardened steel / clean, precise cut / all parts can be replaced
- **Efficient:** easy, durable cutting adjustment / Protection against the risk of hoof infections thanks to blades coated with XYLAN®
- **Ergonomic:** hand and wrist protection, and optimisation of the force exerted are provided by the revolving handle, the angled head and the cushion-shock absorber / non-slip coating

Our recommendation (1★: Recommended, 2★: Strongly recommended, 3★: Best fit)

Ovine and caprine rearing



Small hand



Large hand



Left-handed



**Cutting capacities**

| Material            | Maximum cutting diameter            |
|---------------------|-------------------------------------|
| Sheep / goat hooves | <input checked="" type="checkbox"/> |

**Accessories**



FELCO 902  
Sharpening tool  
Sharpening stone



FELCO 903  
Sharpening tool  
Sharpener



FELCO 910  
Holster  
Leather - With belt loop and clip



FELCO 912  
Holster  
Leather - With belt clip



FELCO 913  
Holster  
In mock leather - With belt loop











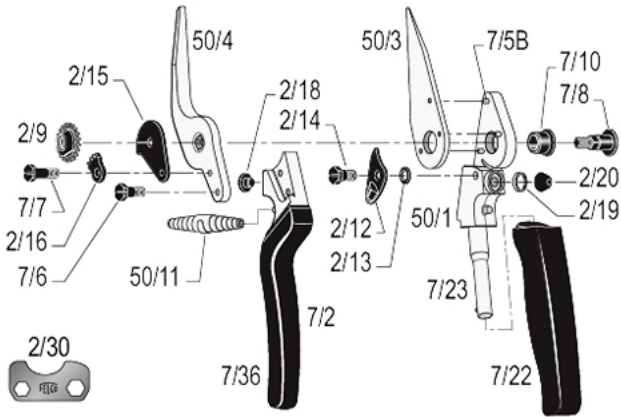







FELCO 980  
Maintenance product  
Spray



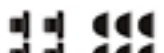















FELCO 990  
Maintenance product  
Grease

### Spare parts



|   | REF. | Designation                | Composition   | UCC bar code  |
|---|------|----------------------------|---|---|
|    | 2/30 | Adjustment key             | 1x 2/30   |   |
|  | 50/3 | Blade                      | 1x 50/3   |   |
|   | 50/4 | Anvil-blade                | 1x 50/4   |  |
|   | 7/90 | Kit                        | 1x 7/7 + 1x 2/16 + 1x 2/9 + 1x 7/8  |  |
|   | 2/92 | Kit                        | 1x 2/15 + 1x 2/18 + 1x 2/14 + 1x 2/12 + 1x 2/13 + 1x 2/20                               |  |
|   | 2/93 | Kit                        | 4x 2/18 + 6x 2/20   |  |
|  | 7/94 | Kit                        | 1x 2/9 + 1x 7/8   |  |
|   | 50/1 | Handle without blade       | 1x 50/1 + 1x 7/23 + 3x 7/5B + 1x 2/19 + 1x 2/20 + 1x 7/10 + 1x 2/13 + 1x 2/12 + 1x 2/14 |   |
|   | 7/2  | Handle without anvil-blade | 1x 7/2 + 1x 2/18 + 1x 7/36  |   |

|   |       |  |          |
|---|-------|--|----------|
|    | 7/22  | Revolving handle                               | 1x 7/22  |
|    | 7/23  | Axis for revolving handle                      | 1x 7/23  |
|     | 7/36  | Plastic coating for anvil-blade / anvil handle | 1x 7/36  |
|    | 7/5B  | Rivet for blade                                | 1x 7/5B  |
|    | 7/6   | Screw for anvil-blade                          | 1x 7/6   |
|    | 7/8   | Bolt   | 1x 7/8   |
|    | 2/9   | Nut  | 1x 2/9   |
|   | 7/10  | Bush   | 1x 7/10  |
|  | 50/11 | White spring                                   | 1x 50/11 |
|  | 2/12  | Thumb catch                                    | 1x 2/12  |
|  | 2/13  | Spring for thumb catch                         | 1x 2/13  |
|  | 2/14  | Screw for thumb catch                          | 1x 2/14  |
|  | 2/15  | Catch plate                                    | 1x 2/15  |
|  | 2/16  | Locking segment                                | 1x 2/16  |
|  | 7/7   | Screw for locking segment                      | 1x 7/7   |
|  | 2/18  | Cushion  | 1x 2/18  |
|  | 2/19  | Edging   | 1x 2/19  |

## Maintenance



### Cleaning

It is advisable to clean your tool after each use.

If your tool is particularly dirty or subject to rusting after exposure to moisture, do not delay cleaning.



### Oiling

After cleaning, it is advisable to oil the tool so as to protect it from corrosion. The oil will also unjam the tool.



### Dismantling the revolving handle

It is advisable to dismantle the revolving handle on a regular basis, so that it does not become jammed.

---

## Replacement parts



### Changing the shock absorber

When the tool closes too abruptly during pruning, and the cushion is in good condition, the shock absorber should be changed.



### Changing the cushion

When the tool closes too abruptly during pruning and the shock absorber is in good condition, the cushion must be changed.



### Changing the thumb catch

When the thumb catch is damaged and loosens when used, even when the screw is readjusted, change it.



### Changing the plastic coatings for handles

If the coatings are badly damaged, you can replace them.

Soak the coatings for 2 minutes in boiling water - recommended glue: Loctite 415.