

FELCO 200A-60 Expert

Two-hand pruning shear - Length 60 cm (23.6 in.) - STRAIGHT cutting head

Made in Switzerland by FELCO



NEW



35mm/1.4in. 600mm/23.6in. 785g/27.7oz.



7 83929 10051 7

- **Reliable:** lightweight aluminium handles / blade and screw-mounted anvil blade made of high-quality hardened steel / clean, precise cut / all parts can be replaced
- **Efficient:** easy, durable cutting adjustment / slimline cutting head / grooved anvil blade for better grip
- **Ergonomic:** shock absorbers protect wrists and arms / handles with non-slip coating



Our recommendation (1 ★: Recommended, 2 ★: Strongly recommended, 3 ★: Best fit)

Viticulture	★★★
Arboriculture	★★★
Horticulture	★★★
Parks and Gardens	★★★
Nursery	★★★
Small hand	★★★
Large hand	★★★
Left-handed	★★★

The points of excellence



Extruded aluminium handles
Lightweight, super-strong materials.



Straight cutting head
Ultra-precise cutting heads for the most demanding work.



Shock absorption system
FELCO's special cushion stops reduce impact at the end of a cut, protecting hand and wrist.

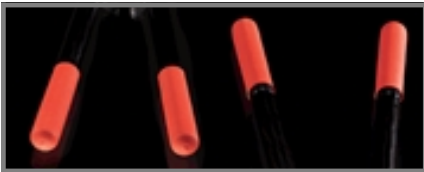

Non-slip coating
Effective and comfortable grip.



Modularity
The tool can be modified at any time to suit changing needs: in this product group, the user can change the type and length of handles, or switch from straight to curved cutting heads.

Accessories



FELCO 300
Picking and Trimming Snip
For a clean cut



FELCO 310
Picking and Trimming Snip
For grape harvesting



FELCO 902
Sharpening tool
Sharpening stone



FELCO 903
Sharpening tool
Sharpener



FELCO 980

Maintenance product

Spray









FELCO 990

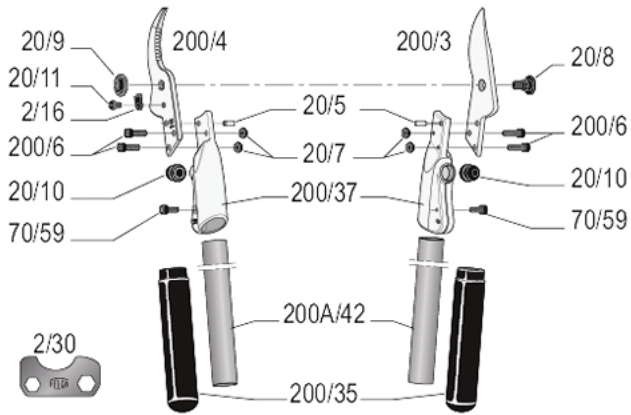





Maintenance product

Grease

Spare parts



	REF.	Designation	Composition	UCC bar code
	2/30	Adjustment key	1x 2/30	
	200/3	Blade	1x 200/3	
	200/4	Anvil-blade	1x 200/4	
	20/93	Kit	2x 20/10	
	20/94	Kit	1x 20/9 + 1x20/8	
	200/37	Joint	1x 200/37 + 1x 20/10 + 1x 20/5 + 1x 70/59	
	200A/42	Aluminium handles length 42 cm (16.5 in.)	2x 200A/42 + 2x 200/35	
	200/35	Coatings	2x 200/35	
	20/5	Pin	1x 20/5	
	70/59	Screw	1x 70/59	

	200/6	Screw	1x 200/6
	20/8	Bolt	1x 20/8
	20/9	Nut	1x 20/9
	20/7	Nut	1x 20/7
	2/16	Locking segment	1x 2/16
	20/11	Screw for locking segment	1x 20/11
	20/10	Shock absorber	1x 20/10

Maintenance



Cleaning

It is advisable to clean your tool after each use.

If your tool is particularly dirty or subject to rusting after exposure to moisture, do not delay cleaning.



Oiling

After cleaning, it is advisable to oil the tool so as to protect it from corrosion. The oil will also unjam the tool.



Sharpening

It is advisable to sharpen your tool at least once a day, but if you feel that your tool is not cutting as well as usual, sharpen it right away!



Dismantling

It is advisable to dismantle your tool on a regular basis, but at the very latest when it appears to be jammed.

Replacement parts



Changing the blade

When the blade and the anvil-blade no longer cross, or when the blade is badly damaged, it is advisable to change it.

Regulate the working of the blade and anvil-blade by adjusting the tightening of the nut. The blade should rub against the anvil-blade over 2/3 of its length.



Changing the anvil-blade

When the blade and anvil-blade no longer cross and the anvil-blade is badly damaged, it is advisable to change it.



Changing the shock absorbers

When the tool closes too abruptly during pruning the shock absorbers should be changed.