

## FELCO 20 Classic

Two-hand pruning shear - Length 43 cm (16.9 in.)

Made in Switzerland by FELCO



35mm/1.4in. 430mm/16.9in. 790g/27.9oz.



- **Reliable:** sturdy handles made of forged aluminium with a lifetime guarantee\* / blade and screw-mounted anvil blade made of high-quality hardened steel / clean, precise cut / all parts can be replaced
- **Efficient:** easy, durable cutting adjustment / slimline cutting head / grooved anvil blade for better grip
- **Ergonomic:** shock absorbers protect wrists and arms / handles with non-slip plastic coating

Our recommendation (1★: Recommended, 2★: Strongly recommended, 3★: Best fit)

Viticulture	★★★
Arboriculture	★★★
Horticulture	★★★
Parks and Gardens	★★★
Nursery	★★★
Small hand	★★★
Large hand	★★★
Left-handed	★★★

### The points of excellence



#### Forged aluminium handles guaranteed for life\*

Lightweight, strong and sturdy thanks to special aluminium alloys and advanced precision forging methods perfectly mastered by FELCO.



#### Straight cutting head

Ultra-precise cutting heads for the most demanding work.

### Accessories



FELCO 300

Picking and Trimming Snip

For a clean cut



FELCO 310

Picking and Trimming Snip

For grape harvesting



FELCO 902

Sharpening tool

Sharpening stone



FELCO 903

Sharpening tool

Sharpener



FELCO 980

Maintenance product

Spray



FELCO 990





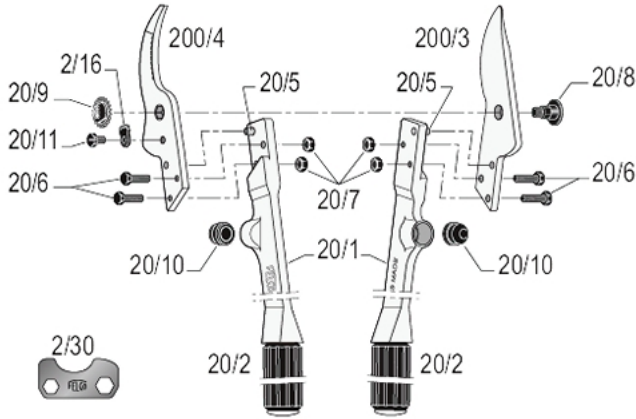

Maintenance product

Grease

### Spare parts



	REF.	Designation	Composition	UCC bar code
	2/30	Adjustment key	1x 2/30	
	200/3	Blade	1x 200/3	
	200/4	Anvil-blade	1x 200/4	
	20/92	Kit	1x 20/11 + 1x 2/16 + 2x 20/6 + 2x 20/7	
	20/93	Kit	2x 20/10	
	20/94	Kit	1x 20/9 + 1x20/8	
	20/1	Handle with coating, pin and shock absorber	1x 20/1 + 1x 20/2 + 1x 20/10 + 1x 20/5	
	20/2	Coating	1x 20/2	
	20/5	Pin	1x 20/5	
	20/6	Screw	1x 20/6	

	20/8	Bolt	1x 20/8
	20/9	Nut	1x 20/9
	20/7	Nut	1x 20/7
	2/16	Locking segment	1x 2/16
	20/11	Screw for locking segment	1x 20/11
	20/10	Shock absorber	1x 20/10

## Maintenance



### Cleaning

It is advisable to clean your tool after each use.

If your tool is particularly dirty or subject to rusting after exposure to moisture, do not delay cleaning.



### Oiling

After cleaning, it is advisable to oil the tool so as to protect it from corrosion. The oil will also unjam the tool.



### Sharpening

It is advisable to sharpen your tool at least once a day, but if you feel that your tool is not cutting as well as usual, sharpen it right away!



### Dismantling

It is advisable to dismantle your tool on a regular basis, but at the very latest when it appears to be jammed.

## Replacement parts



### Changing the blade

When the blade and the anvil-blade no longer cross, or when the blade is badly damaged, it is advisable to change it.

Regulate the working of the blade and anvil-blade by adjusting the tightening of the nut. The blade should rub against the anvil-blade over 2/3 of its length.



### Changing the anvil-blade

When the blade and anvil-blade no longer cross and the anvil-blade is badly damaged, it is advisable to change it.



### Changing the shock absorbers

When the tool closes too abruptly during pruning the shock absorbers should be changed.